

3-FTC-X-LW

表面処理	コード
クローム	3-FTC-C-LW
サテンニッケル	3-FTC-N-LW

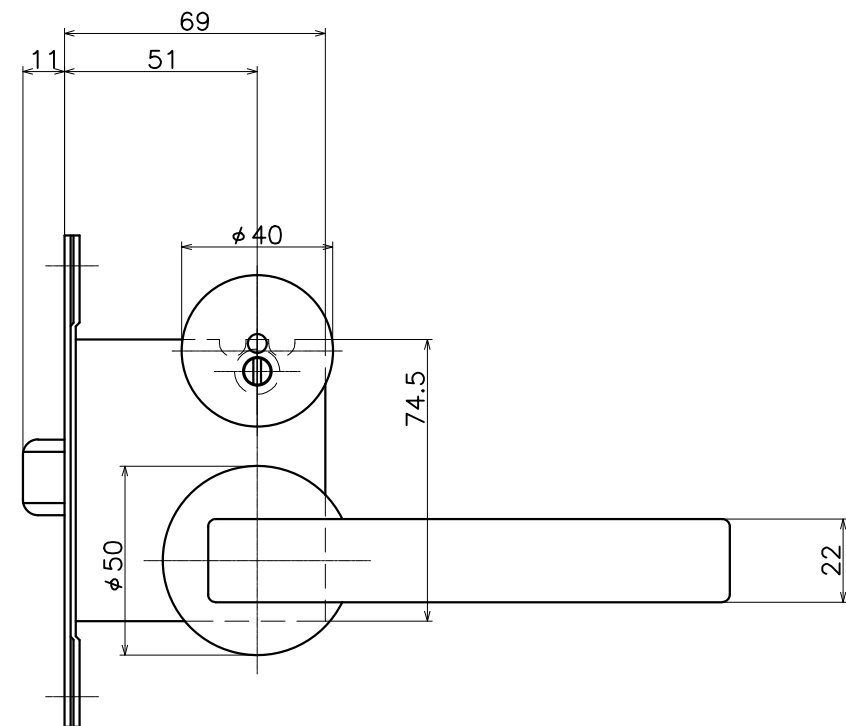
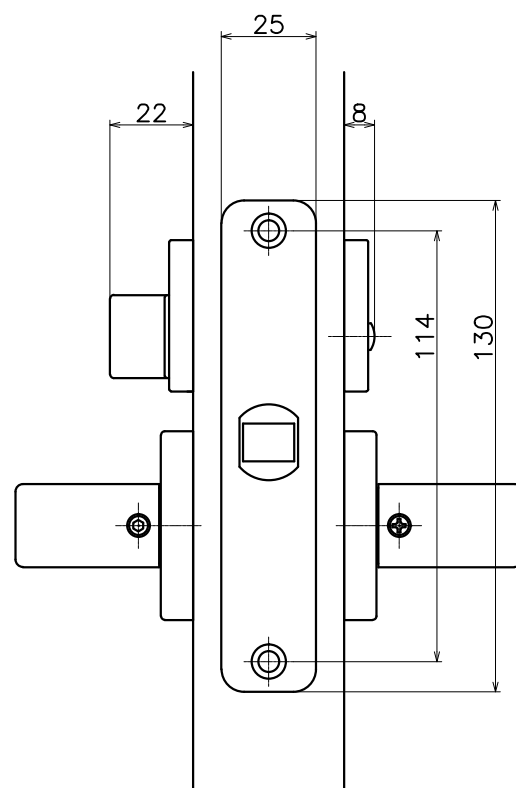
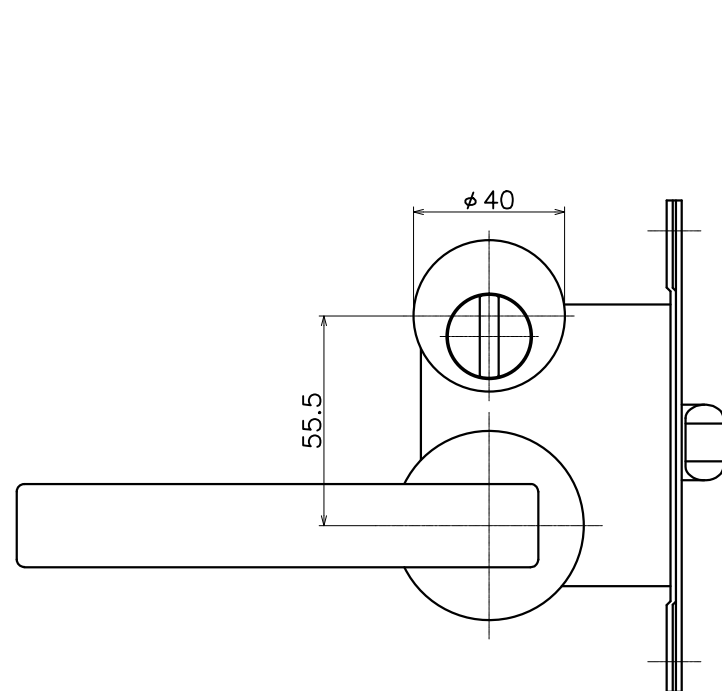
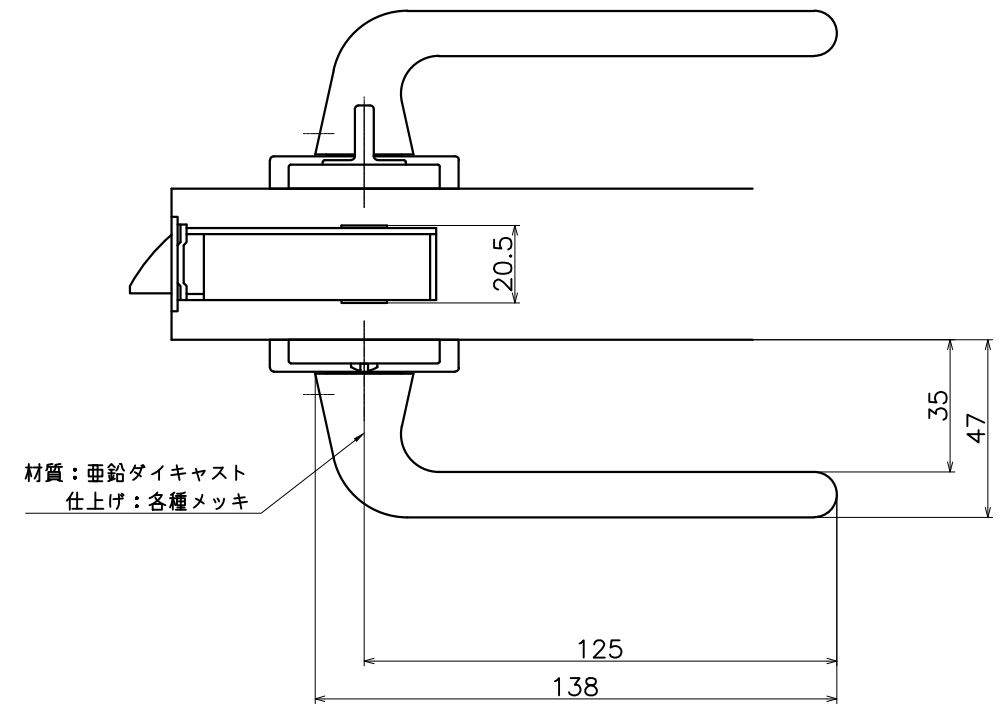

(S=1:2)

KAWAJUN

河渾株式会社
2016/08/05